

GOCCIA MONOPOINT SUSPENSION

D141065-

base number Finish
Options

- To build a product code in our configurator select the specify button on the base model # product page
- To build a manual product code on this datasheet choose from the options listed below in blue font and add the suffix to the base model #

GENERAL

Series: Goccia
Subseries: Goccia Monopoint
Partner: Cangiini & Tucci
Division: Design
Installation: Suspension
Product Type: Pendant
Mounting Location: Ceiling

PHYSICAL

Shape: Abstract
Diameter (mm): 180
Diameter (in): 7 1/8
Height (mm): 320
Height (in): 12 5/8
Max. Overall Height (mm): 1820
Max. Overall Height (in): 71 5/8
Weight (kg): 0.82
Weight (lbs): 1.81
[Fixture Finish: AMB / GRN / PNK / RUB / SKB / SMK / TOB / TRA](#)
Holder Finish: CHR
Fixture Material: Glass / Metal
Primary Material: Glass - Borosilicate
Cable Details: 1500mm Cable

ELECTRICAL

Number of Lamps: 1
Lamp Type: LED Retrofit
Bulb Included: Bulb Not Included
Max. Wattage Per Lamp (W): 4
Lamp Base: E12
Input Voltage (V): 120

LED

OPTICAL

RATINGS AND CERTIFICATIONS

Certified By: Certified for North American Standards
IP rating: IP20

PROJECT	_____
TYPE	_____
SPECIFIER	_____
QUANTITY	_____
DATE	_____

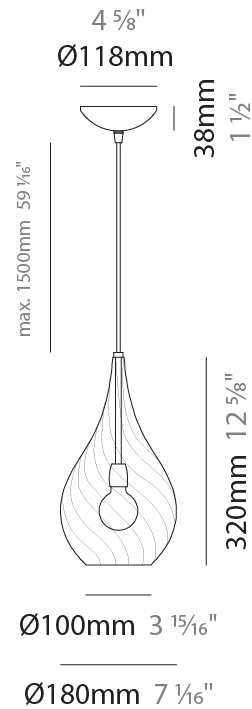

GOCCIA MONOPOINT SUSPENSION

D141065-

PROJECT

TYPE

SPECIFIER

QUANTITY

DATE

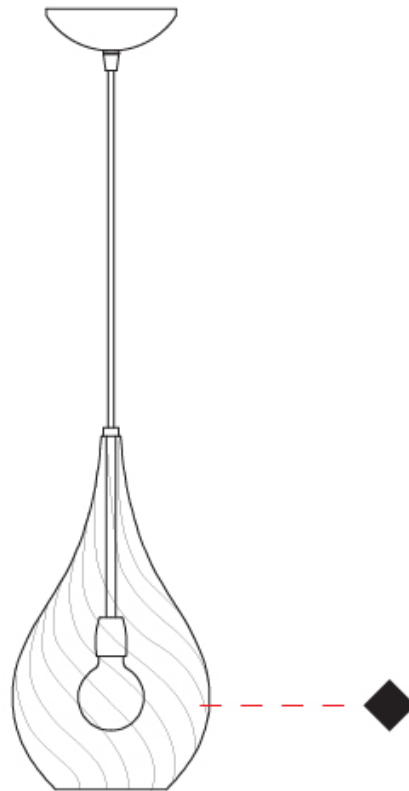

D

GOCCIA MONOPOINT SUSPENSION

D141066-

base number Finish
Options

- To build a product code in our configurator select the specify button on the base model # product page
- To build a manual product code on this datasheet choose from the options listed below in blue font and add the suffix to the base model #

GENERAL

Series: Goccia
Subseries: Goccia Monopoint
Partner: Cangiini & Tucci
Division: Design
Installation: Suspension
Product Type: Pendant
Mounting Location: Ceiling

PHYSICAL

Shape: Abstract
Diameter (mm): 260
Diameter (in): 10 3/4
Height (mm): 420
Height (in): 16 9/16
Max. Overall Height (mm): 1920
Max. Overall Height (in): 75 9/16
Weight (kg): 1.085
Weight (lbs): 2.39
Fixture Finish: [AMB / GRN / PNK / RUB / SKB / SMK / TOB / TRA](#)
Holder Finish: CHR
Fixture Material: Glass / Metal
Primary Material: Glass - Borosilicate
Cable Details: 1500mm Cable

ELECTRICAL

Number of Lamps: 1
Lamp Type: LED Retrofit
Bulb Included: Bulb Not Included
Max. Wattage Per Lamp (W): 8
Lamp Base: E26
Input Voltage (V): 120
Upon Request: 277Vac / GU24

LED

OPTICAL

RATINGS AND CERTIFICATIONS

Certified By: Certified for North American Standards
IP rating: IP20

PROJECT
TYPE
SPECIFIER
QUANTITY
DATE

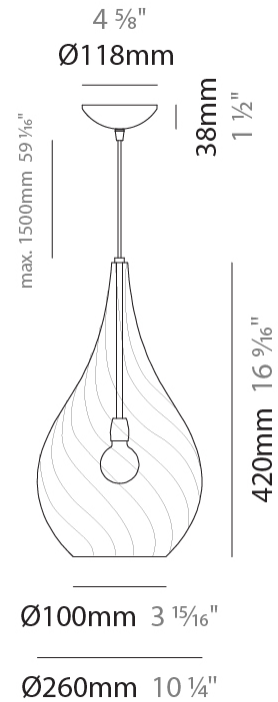

GOCCIA MONOPOINT SUSPENSION

D141066-

PROJECT

TYPE

SPECIFIER

QUANTITY

DATE

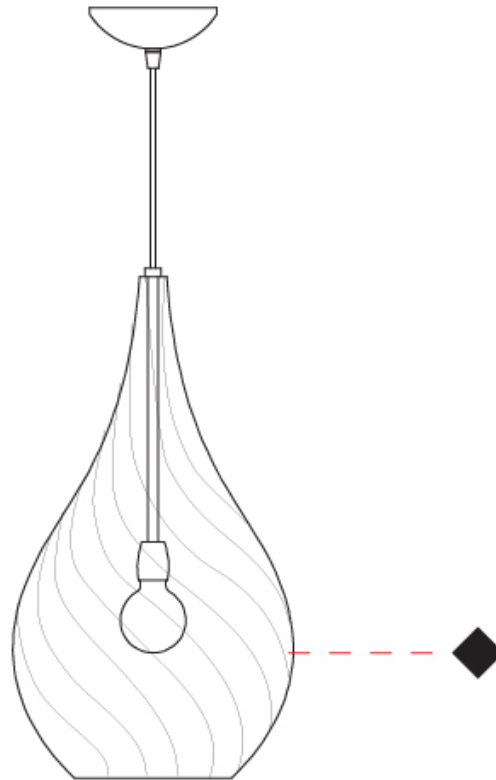

D

PROJECT	_____
TYPE	_____
SPECIFIER	_____
QUANTITY	_____
DATE	_____

GOCCIA 2 LIGHT SWAG SUSPENSION

D141072-

base number _____
 Finish _____
 Options _____

- To build a product code in our configurator select the specify button on the base model # product page
- To build a manual product code on this datasheet choose from the options listed below in blue font and add the suffix to the base model #

GENERAL

Series: Goccia _____
 Subseries: Goccia 2 Light Swag _____
 Partner: Cangiini & Tucci _____
 Division: Design _____
 Installation: Suspension _____
 Product Type: Pendant _____
 Mounting Location: Ceiling _____

PHYSICAL

Shape: Abstract _____
 Diameter (mm): 180 _____
 Diameter (in): 7 1/8 _____
 Height (mm): 320 _____
 Height (in): 12 5/8 _____
 Max. Overall Height (mm): 1820 _____
 Max. Overall Height (in): 71 5/8 _____
 Weight (kg): 1.54 _____
 Weight (lbs): 3.39 _____
 Fixture Finish: [AMB](#) / [GRN](#) / [PNK](#) / [RUB](#) / [SKB](#) / [SMK](#) / [TOB](#) / [TRA](#) _____
 Holder Finish: CHR _____
 Fixture Material: Glass / Metal _____
 Primary Material: Glass - Borosilicate _____
 Cable Details: 1500mm Cable _____

ELECTRICAL

Number of Lamps: 2 _____
 Lamp Type: LED Retrofit _____
 Bulb Included: Bulb Not Included _____
 Total Output Wattage (W): 8 _____
 Max. Wattage Per Lamp (W): 4 _____
 Lamp Base: E12 _____
 Input Voltage (V): 120 _____

LED

OPTICAL

RATINGS AND CERTIFICATIONS

Certified By: Certified for North American Standards _____
 IP rating: IP20 _____

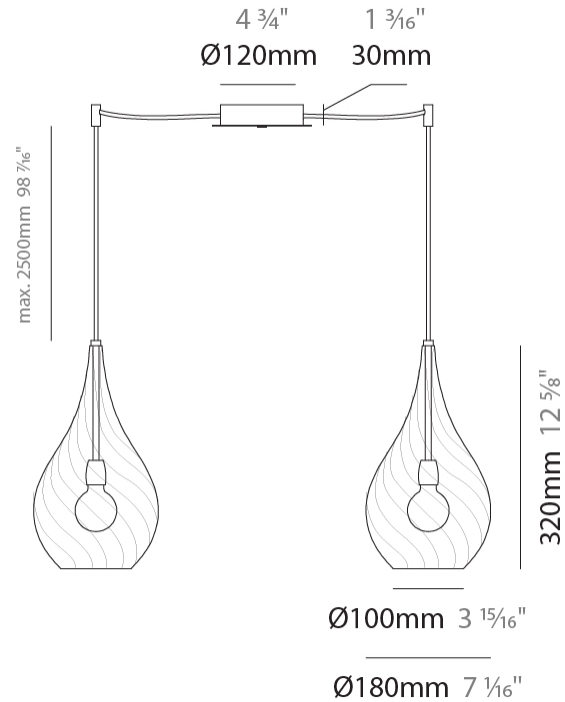

GOCCIA 2 LIGHT SWAG SUSPENSION

D141072-

PROJECT	_____
TYPE	_____
SPECIFIER	_____
QUANTITY	_____
DATE	_____

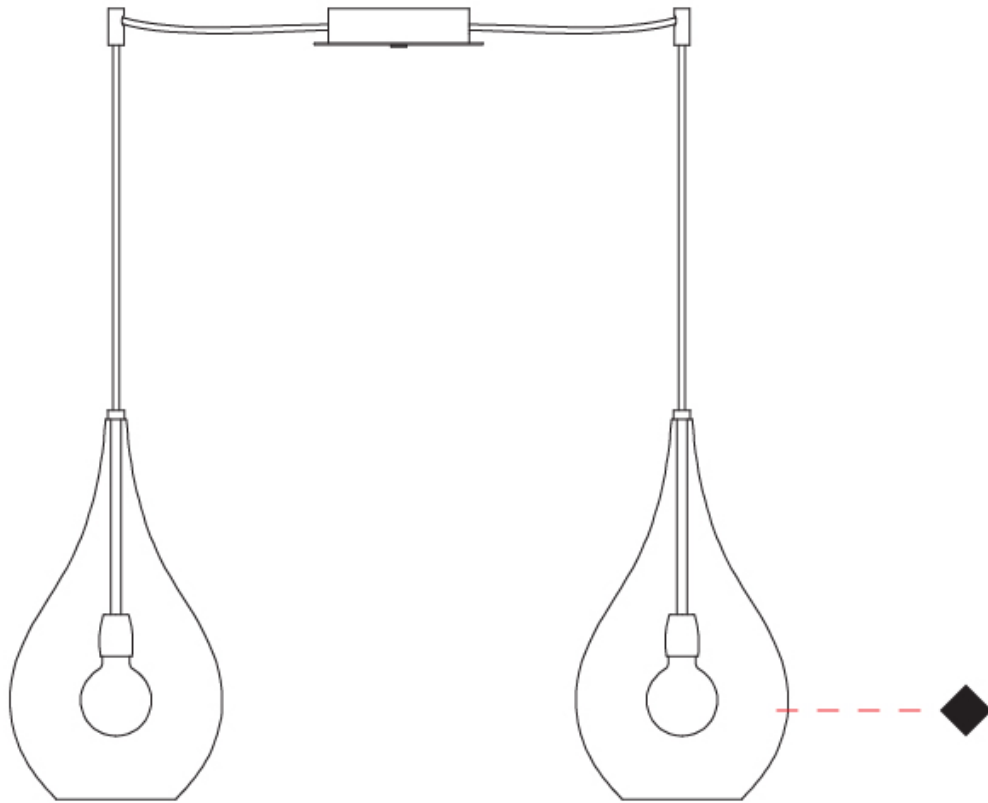

D

PROJECT	_____
TYPE	_____
SPECIFIER	_____
QUANTITY	_____
DATE	_____

GOCCIA 3 LIGHT LINEAR SUSPENSION

D141073-

base number Finish
Options

- To build a product code in our configurator select the specify button on the base model # product page
- To build a manual product code on this datasheet choose from the options listed below in blue font and add the suffix to the base model #

GENERAL

Series: Goccia
 Subseries: Goccia 3 Light Linear
 Partner: Cangiini & Tucci
 Division: Design
 Installation: Suspension
 Product Type: Pendant
 Mounting Location: Ceiling

PHYSICAL

Shape: Abstract
 Length (mm): 1200
 Length (in): 47 1/4
 Height (mm): 320
 Height (in): 12 5/8
 Max. Overall Height (mm): 1820
 Max. Overall Height (in): 71 5/8
 Weight (kg): 3.4
 Weight (lbs): 7.48
[Fixture Finish: AMB / GRN / PNK / RUB / SKB / SMK / TOB / TRA](#)
 Holder Finish: PSS
 Fixture Material: Glass / Metal
 Primary Material: Glass - Borosilicate
 Cable Details: 1500mm Cable

ELECTRICAL

Number of Lamps: 3
 Lamp Type: LED Retrofit
 Bulb Included: Bulb Not Included
 Total Output Wattage (W): 12
 Max. Wattage Per Lamp (W): 4
 Lamp Base: E12
 Input Voltage (V): 120

LED

OPTICAL

RATINGS AND CERTIFICATIONS

Certified By: Certified for North American Standards
 IP rating: IP20

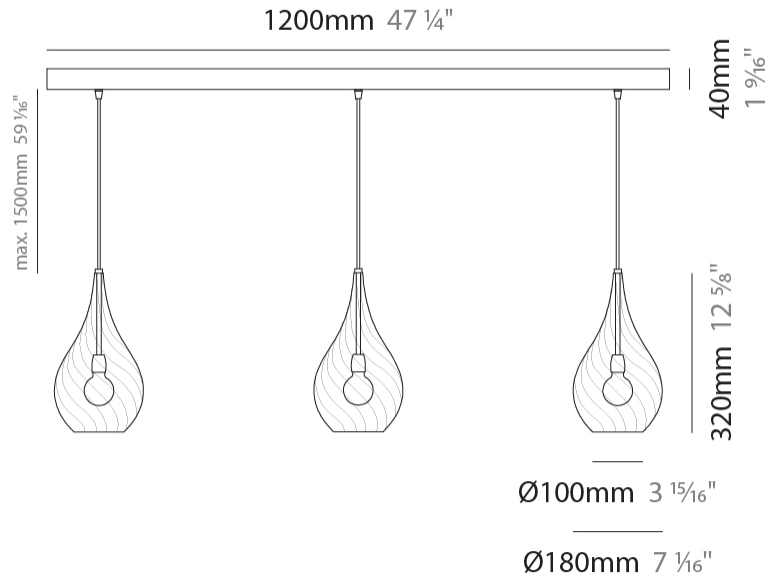

GOCCIA 3 LIGHT LINEAR SUSPENSION

D141073-

PROJECT	_____
TYPE	_____
SPECIFIER	_____
QUANTITY	_____
DATE	_____

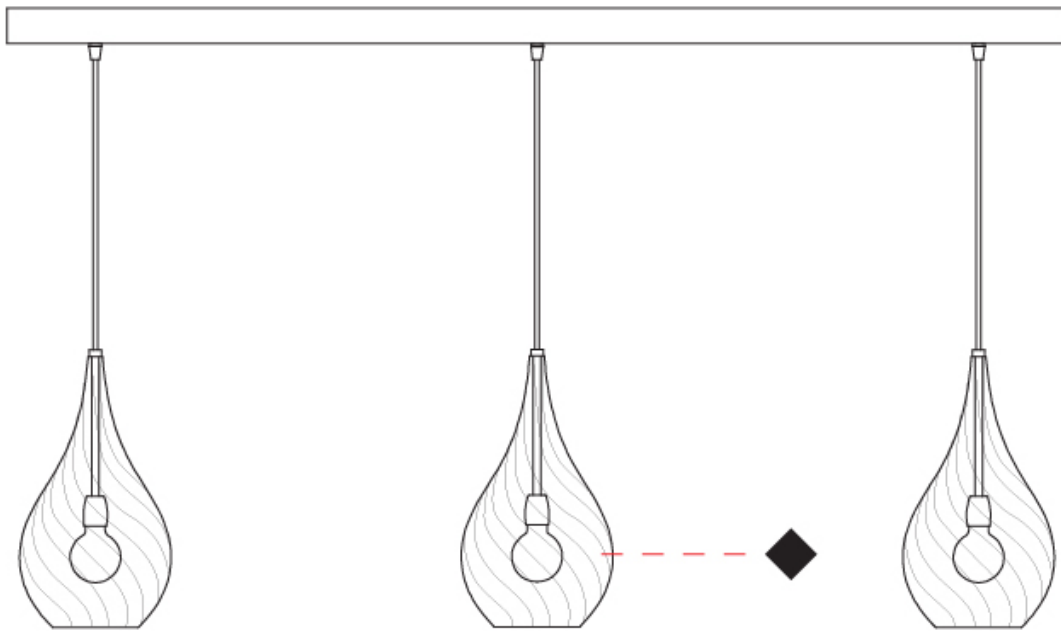

D

PROJECT	
TYPE	
SPECIFIER	
QUANTITY	
DATE	

GOCCIA 3 LIGHT CLUSTER SUSPENSION

D141074-

base number Finish
Options

- To build a product code in our configurator select the specify button on the base model # product page
- To build a manual product code on this datasheet choose from the options listed below in blue font and add the suffix to the base model #

GENERAL

Series: Goccia
 Subseries: Goccia 3 Light Cluster
 Partner: Cangiini & Tucci
 Division: Design
 Installation: Suspension
 Product Type: Pendant
 Mounting Location: Ceiling

PHYSICAL

Shape: Abstract
 Length (mm): 430
 Length (in): 16 ¹⁵/₁₆
 Max. Overall Height (mm): 1500
 Max. Overall Height (in): 59 ¹/₁₆
 Weight (kg): 4.6
 Weight (lbs): 10.12
 Fixture Finish: [AMB](#) / [GRN](#) / [PNK](#) / [RUB](#) / [SKB](#) / [SMK](#) / [TOB](#) / [TRA](#)
 Holder Finish: PSS
 Fixture Material: Glass / Metal
 Primary Material: Glass - Borosilicate
 Cable Details: 1500mm Cable

ELECTRICAL

Number of Lamps: 3
 Lamp Type: LED Retrofit
 Bulb Included: Bulb Not Included
 Total Output Wattage (W): 16
 Max. Wattage Per Lamp (W): 8 + 8
 Lamp Base: E26 + E12
 Input Voltage (V): 120

LED

OPTICAL

RATINGS AND CERTIFICATIONS

Certified By: Certified for North American Standards
 IP rating: IP20

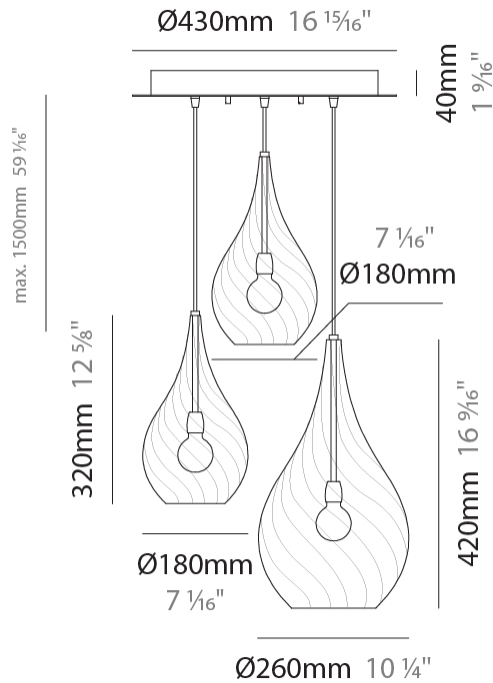

GOCCIA 3 LIGHT CLUSTER SUSPENSION

D141074-

PROJECT	_____
TYPE	_____
SPECIFIER	_____
QUANTITY	_____
DATE	_____

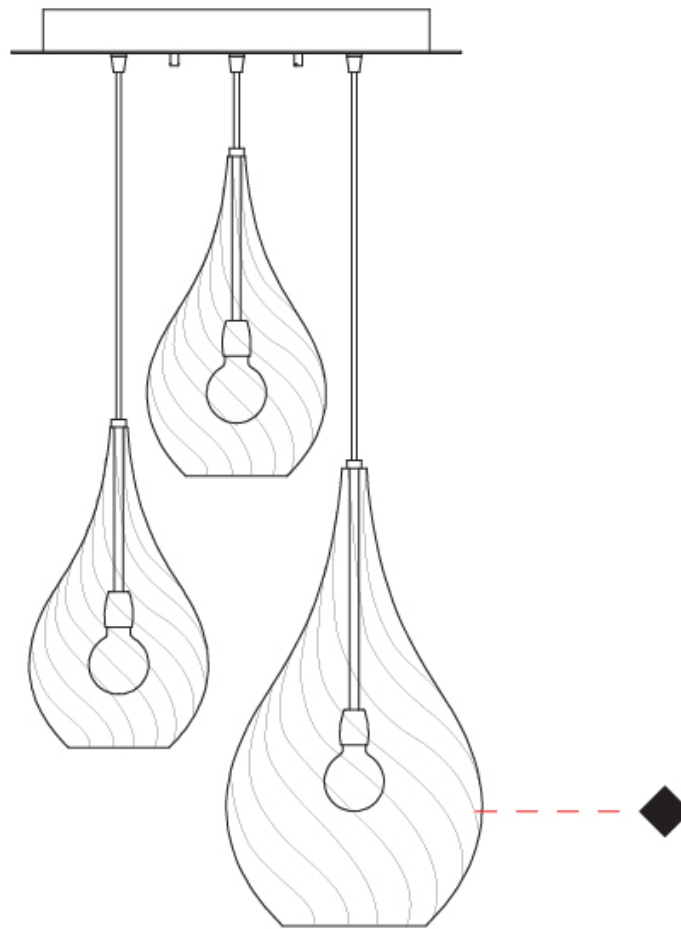

D

GOCCIA PORTABLE

D144006-

base number Finish
Options

PROJECT
TYPE
SPECIFIER
QUANTITY
DATE

- To build a product code in our configurator select the specify button on the base model # product page
- To build a manual product code on this datasheet choose from the options listed below in blue font and add the suffix to the base model #

GENERAL

Series: Goccia
 Partner: Cangini & Tucci
 Division: Design
 Installation: Portable
 Product Type: Table
 Mounting Location: Table

PHYSICAL

Shape: Abstract
 Diameter (mm): 300
 Diameter (in): 11 ¹³/₁₆"
 Height (mm): 550
 Height (in): 21 ⁵/₈"
 Weight (kg): 0.97
 Weight (lbs): 2.13
 Fixture Finish: [AMB / GRN / PNK / RUB / SKB / SMK / TOB / TRA](#)
 Holder Finish: CHR
 Fixture Material: Glass / Metal
 Primary Material: Glass - Borosilicate
 Cable Details: 1500mm Cable

ELECTRICAL

Number of Lamps: 1
 Lamp Type: LED Retrofit
 Bulb Included: Bulb Not Included
 Max. Wattage Per Lamp (W): 4
 Lamp Base: E12
 Input Voltage (V): 120

LED

OPTICAL

RATINGS AND CERTIFICATIONS

Certified By: Certified for North American Standards
 IP rating: IP20



Ø300mm 11 ¹³/₁₆"

Ø200mm 7 ⁷/₈"

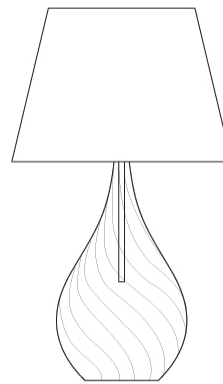

210mm 8 ¹/₄"

550mm 21 ⁵/₈"

Ø180mm 7 ¹/₁₆"



GOCCIA PORTABLE

D144006-

PROJECT	_____
TYPE	_____
SPECIFIER	_____
QUANTITY	_____
DATE	_____

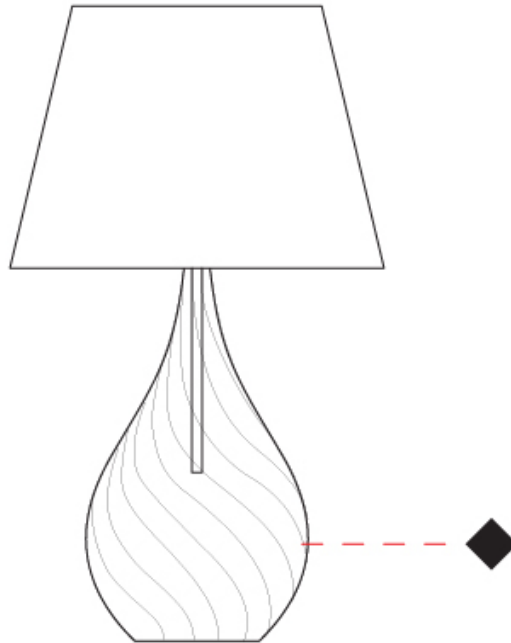

D

GOCCIA PORTABLE

D144007-

base number Finish
Options

- To build a product code in our configurator select the specify button on the base model # product page
- To build a manual product code on this datasheet choose from the options listed below in blue font and add the suffix to the base model #

GENERAL

Series: Goccia
 Partner: Cangini & Tucci
 Division: Design
 Installation: Portable
 Product Type: Table
 Mounting Location: Table

PHYSICAL

Shape: Abstract
 Diameter (mm): 400
 Diameter (in): 15 ¾"
 Height (mm): 700
 Height (in): 27 ⅞"
 Weight (kg): 1.48
 Weight (lbs): 3.26
 Fixture Finish: [AMB / GRN / PNK / RUB / SKB / SMK / TOB / TRA](#)
 Holder Finish: CHR
 Fixture Material: Glass / Metal
 Primary Material: Glass - Borosilicate
 Cable Details: 1500mm Cable

ELECTRICAL

Number of Lamps: 1
 Lamp Type: LED Retrofit
 Bulb Included: Bulb Not Included
 Max. Wattage Per Lamp (W): 8
 Lamp Base: E26
 Input Voltage (V): 120
 Upon Request: 277Vac / GU24

LED

OPTICAL

RATINGS AND CERTIFICATIONS

Certified By: Certified for North American Standards
 IP rating: IP20

PROJECT
TYPE
SPECIFIER
QUANTITY
DATE

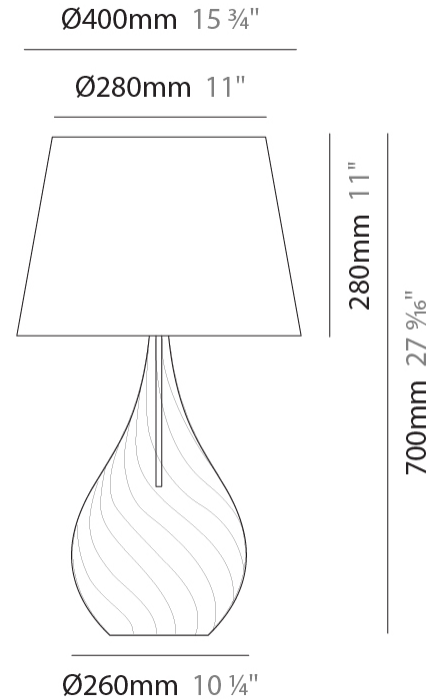

GOCCIA PORTABLE

D144007-

PROJECT	_____
TYPE	_____
SPECIFIER	_____
QUANTITY	_____
DATE	_____

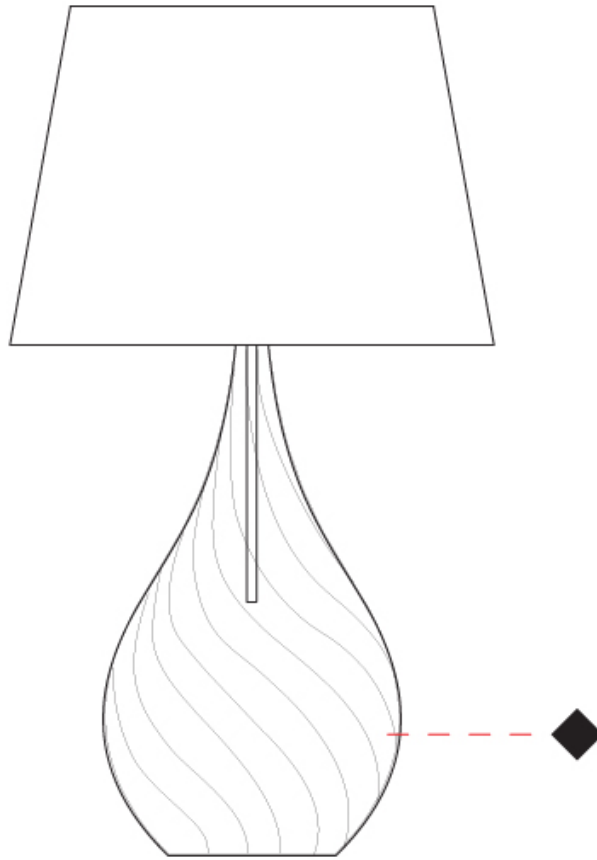

D

GOCCIA COLOR FINISH CHART

PROJECT	_____
TYPE	_____
SPECIFIER	_____
QUANTITY	_____
DATE	_____

Fixture Finish

Amber - AMB



Green - GRN



Pink - PNK



Ruby - RUB



Sky Blue - SKB



Smoke - SMK



Tobacco - TOB



Transparent - TRA



Holder Finish

Chrome - CHR



Polished Stainless Steel - PSS



Digital: Not all screens are calibrated the same, and therefore, colors will appear differently between screens.

Physical: When texture is involved, there will be variations in color, character and tone within a product series and between product families.



PROJECT	
TYPE	
SPECIFIER	
QUANTITY	
DATE	

LEGEND

floor-mounted	pivotal	special LED (upon request) RGB, RGBW, tunable, gold+, meat+, art+, fashion+
wall and ceiling: recessed and surface mounted	rotating	warm dim / natural dimming LED
ceiling-mounted and wall-mounted	illuminate tilted	rechargeable battery powered
wall-mounted	color of suspension cable	fixture with natural vivid LED (upon request)
omni-directional light distribution	length of suspension cable	color rendering index
direct light distribution	reflector degree selection	color temperature
direct/indirect light distribution	super spot	lumen (luminous flux)
indirect light distribution	lens	efficacy (lumens per watt)
asymmetric light distribution	lens pack	Unified Glare Rating (UGR) range from 5-40
aura light distribution	shine ring	marine grade (AISI 316 stainless steel)
round wall or ceiling cut-out	integrated shine ring with diffuser	walk on
square wall or ceiling cut-out	free individual colors 01-29	drive on
the supplied jig specifies the cutout dimensions	individual colors: 00 (free of charge), 01-25 (extra charge)	Dark Sky Compliance
minimum distance (meters) lamp - object	luminaire part to be colored (F1)	Americans with Disabilities Act (less than 4" off the wall located between 27"-84" from floor)
recessed depth	luminaire part to be colored (F2)	lamp protected against explosion
ceiling thickness in mm	luminaire part to be colored (F3)	blown glass using traditional methods by master glass blower
ceiling thickness selection	luminaire part to be colored (F4)	acoustic material
dimmable DP (phase), DV (0-10V), DD (dali), DS (step-dim)	luminaire part to be colored (F5)	protection class I, protection insulation
included or excluded LED driver/transformer/control gear	color of 3-circuit adaptor	protection class II, protection insulation
separately switchable	indirect diffuser	ETL Certified to UL and CSA Standards
sensor	direct diffuser	UL Certified to UL and CSA Standards
remote control	ball-proof (upon request)	CSA Certified to UL and CSA Standards
available upon request	accessory	Certified for North American Standards

IP RATING

IP20	protected against ingress of solid bodies greater than 12.5mm (finger)
IP33	protected against ingress of solid bodies greater than 2.5mm protected against sprays of water up to 60 degrees from the vertical (rain)
IP40	protected against ingress of solid bodies greater than 1mm (wire) no protection against the ingress of moisture
IP43	protected against ingress of solid bodies greater than 1mm (wire) protected against sprays of water up to 60 degrees from the vertical (rain)
IP44	protected against ingress of solid bodies greater than 1mm (wire) protected against water splashed from all directions
IP54	protected against limited ingress of dust (wet rooms/covered outdoor areas) protected against water splashed from all directions
IP65	protected against ingress of dust protected against jets of water
IP66	protected against ingress of dust protected against powerful jets of water or heavy seas
IP67	protected against ingress of dust protected against immersion of water between 15cm - 1m for 30 minutes
IP68	protected against ingress of dust protected against immersion of water under pressure for long periods

IK RATING

IK01	protected against 0.14 joules impact (equivalent to 0.25kg mass dropped from 56mm above the surface)
IK02	protected against 0.2 joules impact (equivalent to 0.25kg mass dropped from 80mm above the surface)
IK03	protected against 0.35 joules impact (equivalent to 0.25kg mass dropped from 140mm above the surface)
IK04	protected against 0.5 joules impact (equivalent to 0.25kg mass dropped from 200mm above the surface)
IK05	protected against 0.7 joules impact (equivalent to 0.25kg mass dropped from 280mm above the surface)
IK06	protected against 1 joules impact (equivalent to 0.25kg mass dropped from 400mm above the surface)
IK07	protected against 2 joules impact (equivalent to 0.5kg mass dropped from 400mm above the surface)
IK08	protected against 5 joules impact (equivalent to 1.7kg mass dropped from 300mm above the surface)
IK09	protected against 10 joules impact (equivalent to 5.0kg mass dropped from 200mm above the surface)
IK10	protected against 20 joules impact (equivalent to 5.0kg mass dropped from 400mm above the surface)